

LED Exterior Flush Mount

EC18705
INSTALLATION SHEET

START FROM HERE

- Make sure power is completely off at the fuse box.
- Have your fixture installed by a qualified licensed electrician.
- Prepare everything in a clear area.
- Wear gloves at all times during this installation.
- Read instructions carefully before you start assembly.
- Keep this instruction sheet for future reference.

Technical Support: 1-855-855-8926

Please Note:

- All Kuzco LED fixtures come with pre-wired LED module(s).
- Unless instructed to do so, please do not touch any part of the LED module(s) as any unnecessary contact with the module could cause permanent damage.
- For dimming, an ELV (Electronic Low Voltage) type of dimmer is required.
- Must be installed on a covered ceiling
- 120V input

- 1.** Remove the fixture from its original packaging. Next, remove the front cover (**2a**) from the canopy (**1c**). Connect all wires correctly black to black "L", white to white "N" and the ground wire with provided marrettes (**1b**) from the hardware package. Attach the canopy (**1c**) to the electrical junction box (**1a**) on the ceiling using the two screws (**1d**) provided in the hardware package.
- 2.** Align front cover (**2a**) with threads on canopy (**1c**), gently turn the front cover clockwise until fully inserted back on, do not overtighten.
- 3.** You have now completed the installation of your fixture, enjoy.

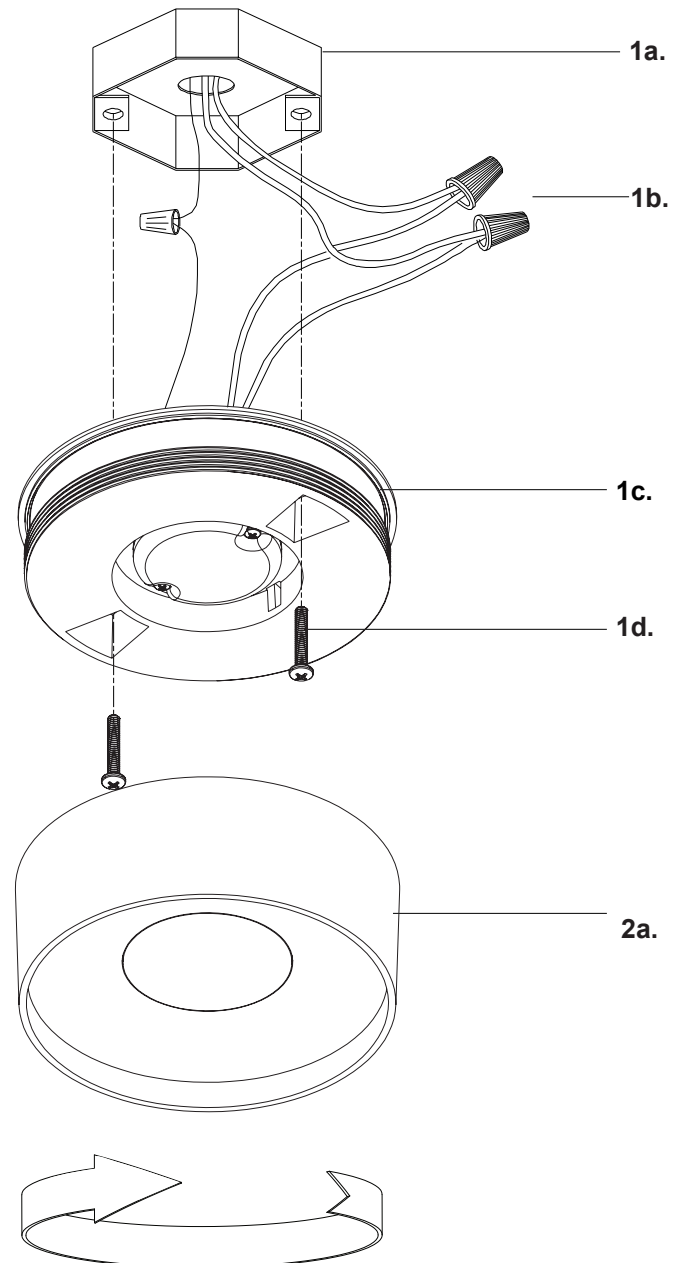

KUZCO

19054 28th Avenue Surrey, BC Canada V3Z 6M3
T: 604 538 7162 TF: 1-855 85 KUZCO F: 604 538 7196
W: kuzcolighting.com
20190312