

INSTALLATION INSTRUCTIONS

JNUM-3-BK

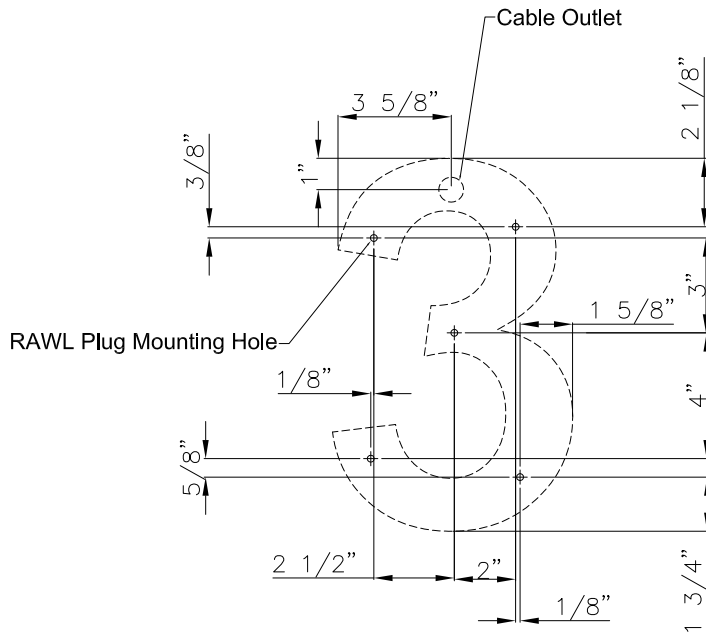

Mounting Screws Diagram

IMPORTANT GENERAL SAFEGUARDS:

CAUTION: To avoid the possibility of electric shock, make sure to unplug or turn off power supply before installation.

- Review the diagrams thoroughly before installation.
- Installation and electrical connections must be done in accordance with National Electrical and local codes, and should be performed by a qualified, licensed electrician.
- Do not let power supply touch hot surfaces.
- The use of accessory equipment not recommended by the original manufacturer may cause an unsafe condition.
- Do not use this equipment for other than intended use.
- All servicing should be performed by qualified personnel only.

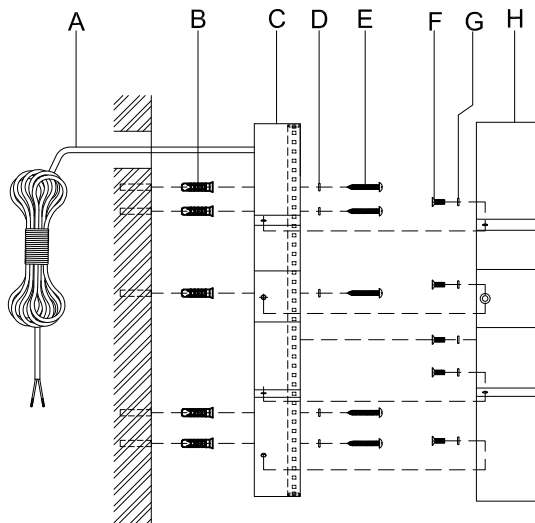

PARTS LIST:

CAUTION: Make sure all parts have been accounted for prior to discarding carton and packing materials.

- A. 24VDC Black Cord
- B. 1/4" Plastic Anchor
- C. Back Plate
- D. Waterproof Rubber "O" Rings
- E. Plastic Anchor Screw
- F. Countersunk Screws
- G. Waterproof Rubber "O" Rings
- H. Number Front Face

Fixture installation steps:

1. Prepare all the parts as per PARTS LIST.
2. Drill mounting holes on the wall for Back Plate(C), place the 1/4" Plastic Anchor(B) into the mounting holes;And then use the Waterproof Rubber "O" Rings(D) and Plastic Anchor Screw(E) to fix Back Plate(C).
3. Attach Number Front Face(H) to Backplate(C) with Countersunk Screws(F) and Waterproof Rubber "O" Rings(G) firmly.
4. Make wire connections with LED driver, red to red and black to black.
5. Turn on.